



INTRODUCTION

This **Technical User Guide** contains warnings and guidance for correct and safe operation of the product. These instructions must be followed at all times. TPL Vision will not be held responsible for problems caused by using the product contrary to these instructions and the Warranty will be deemed invalid.



UNPACKING

Before unpacking, leave the parcel for 24 hours in the room where the product will be used (see «Temperature Conditioning»). This product is packed at the factory using suitable materials for safe transport. To open the package, do not use any cutting blade to avoid damaging the product(s). Please use the delivered accessories if needed. (Do not use any other products or equivalents to replace the delivered accessories).

In the event of damage occurring during shipping, it must be reported to the carrier at time of delivery (including noting the damage in writing on the delivery documents). It is also your responsibility to notify TPL Vision in writing of the damage within 24 hours of receipt of the package. If these instructions are not followed, TPL Vision reserves the right not to accept requests for return and exchange of damaged products.

RISK CLASS

The applicable Standard EN-62471 classifies LED Lighting into 4 classes according to their degree of hazard severity. The table below summarises the risks associated with our various standard products.

Colour	Class	Risk
White WHI, Green 525 nm, Red 630 nm	0	none
Blue 470 nm, IR 850 nm	1	low
–	2	moderate
UV 405 nm	3	high

TPL Vision can provide **guidance notes to minimise photo-biological risks**, including the nominal minimum operating distance.

Please contact TPL Vision through your **usual representative** for this information.

In all cases, TPL Vision recommends the use of **the protection glasses** that are listed in its catalog.



WATERPROOF IP69K WASHDOWN BARLIGHT

TECHNICAL USER GUIDE

P2/8

OPERATING GUIDANCE

1 - TEMPERATURE CONDITIONING

If the ambient temperature is $< 20^{\circ}\text{C}$ ($< 68^{\circ}\text{F}$), before setting up the product on the machine, please **store the product for 24 hours** in its **packaging**, and at the expected operating temperature.

IP69K bars come with a vent which balances the pressure between the inside and outside of the tube. It also prevents moisture (in a liquid form) from getting inside the tube. However air moisture (in a gaseous form) can still go in and out of the vent due to the pressure variations inside the tube. This moisture can't be removed without an air dryer so it is critical to prevent the moisture from condensing.

Keeping the product in its packaging will help slow down the processes of adjusting the product temperature to the operating one, balancing the pressure inside the tube.

If the product cannot be left in its packaging for 24 hours, then the power supply needs to be connected as soon as possible so that the internal fans are operational.

Temperature conditioning does not apply if the ambient temperature is $> 20^{\circ}\text{C}$ ($> 68^{\circ}\text{F}$).

2 - USE

Condensation can occur inside the bar when the inside air is cold and touches a warm surface.

As a result:

- do not place the product where the temperature may vary rapidly,
- never clean a cold product with warm water.

HOW TO KEEP THE BAR WARM ?

The LEDs heat the aluminum profile and the fans help to homogenize the temperature inside.

- Try to leave the LEDs and the fans turned on permanently, especially when cleaning.

- If the bar has been used in Strobe operation or dimmed, turn on the LEDs at 100%, during at least 3 hours before washing down and leave them on 3 hours after.

- **Ambient temperature $\geq -20^{\circ}\text{C}$ and $\leq 20^{\circ}\text{C}$ ($\geq -4^{\circ}\text{F}$ and $\leq 68^{\circ}\text{F}$):**

Bar can be operated in Continuous working and Strobe mode.

- **Ambient temperature $> 20^{\circ}\text{C}$ and $\leq 40^{\circ}\text{C}$ ($> 68^{\circ}\text{F}$ and $\leq 104^{\circ}\text{F}$):**

Only use the bar in Strobe operation, with a duty cycle $< 20\%$ and on-time duration $< 20\text{ mS}$.

- **Ambient temperature $> 40^{\circ}\text{C}$ and $\leq 60^{\circ}\text{C}$ ($> 104^{\circ}\text{F}$ and $\leq 140^{\circ}\text{F}$):**

Only use the bar in Strobe operation, with a duty cycle $< 5\%$ and on-time duration $< 2\text{ mS}$.

3 - SHUTTING DOWN FOR THE WEEK-END

- **Ambient temperature $\leq 20^{\circ}\text{C}$ ($\leq 68^{\circ}\text{F}$):**

Do not wash down before having turned on the LEDs for at least 3 hours.

- **Ambient temperature $> 20^{\circ}\text{C}$ ($> 68^{\circ}\text{F}$):**

No constraint.

This product is IP69K tested and certified. If you see water inside the tube and the tube integrity is still intact, then it must be condensate water and TPL Vision cannot be held responsible for this.



DIMENSIONS & FIXING

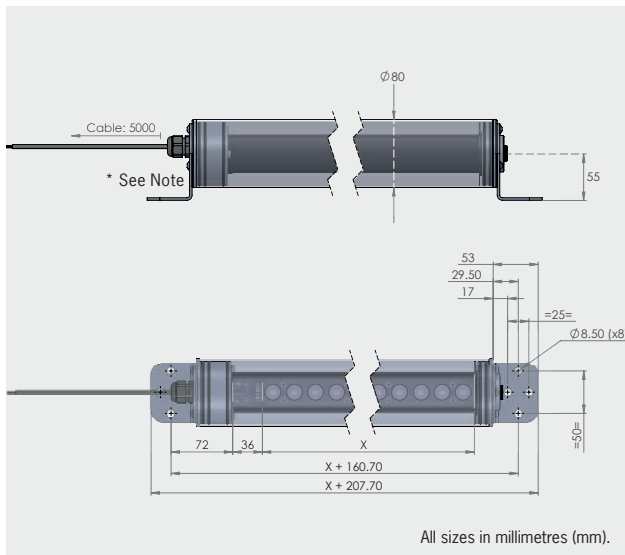

NOTE: the Swivel L-Brackets (360 Degrees) illustrated (*) are included with the product.

X = illumination size.

Options for X:

125	250	375	500
-----	-----	-----	-----

625	750	875	1000
-----	-----	-----	------

1125	1250
------	------

Please mount the structure on a **FLAT SURFACE** or use **rubber vibration dampers**.

To attach the product to your structure, it is advised to use a shore 60 or more rubber washer between the L-Bracket and your structure. This will help with reducing constraints on the product due to uneven mounting surfaces.

OPERATION RELIABILITY

In Strobe mode, the light operation time is equivalent to the strobe signal activation time.

The product is optimised for a lifespan >50kh in a 40°C (104°F) atmosphere.

MATERIALS

The principal materials used in the manufacture of this product have been selected to be appropriate and safe for a Food or Pharmaceutical environment.

- **Tube:** PMMA (Poly(methyl methacrylate) - also known as acrylic, acrylic glass, or plexiglass.
- **Tube End Sections:** 316L Stainless Steel.
- **Bracket:** 316L Stainless Steel.



WATERPROOF IP69K WASHDOWN BARLIGHT TECHNICAL USER GUIDE

ELECTRICAL CONNECTION

Cable 5 wires

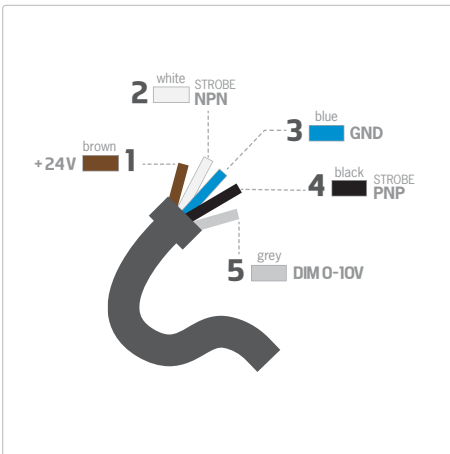

STROBE MODE (PNP) :

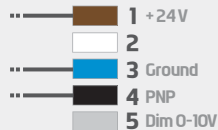

STROBE MODE (NPN) :

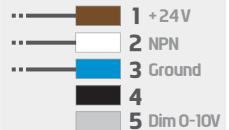

CONTINUOUS MODE :

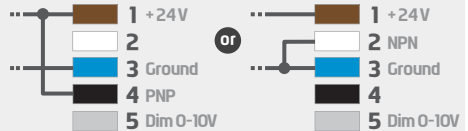

EMC IMMUNITY CONNECTIONS: for greater EMC immunity when using the light under Strobe operation, configure the signal connections as illustrated here. For Dimming, the Pin (5) should be connected to a voltage between 0V and 10V to ensure light output is correctly configured.



STROBE PNP :

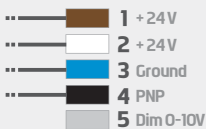

STROBE NPN :

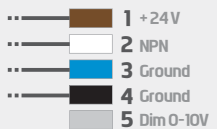

STROBE TRIGGERING MODE - PNP AND NPN

PNP : from 5 to 24V for 100% ON. From 0 to 1V for 100% OFF.

NPN : less than 1V for 100% ON. Above 2V for 100% OFF. Max 20V.

The fans operate as soon as the 24V is switched on. The LEDs only work if the PNP or NPN input is activated.



CONTROL

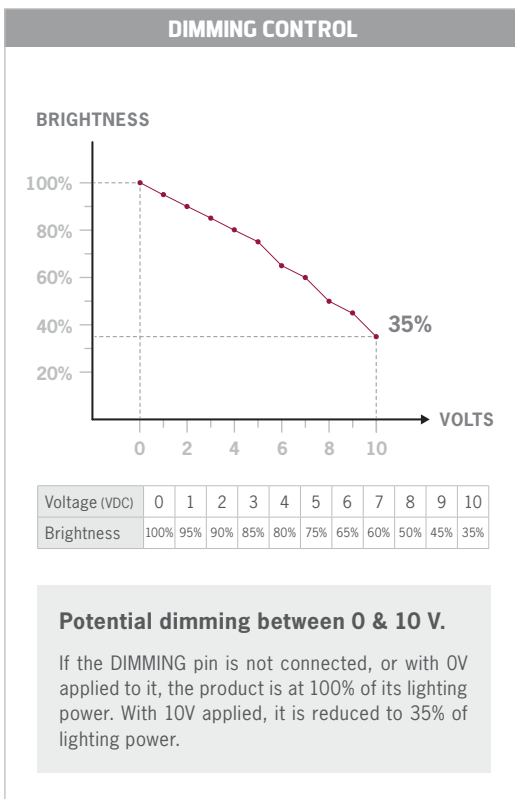
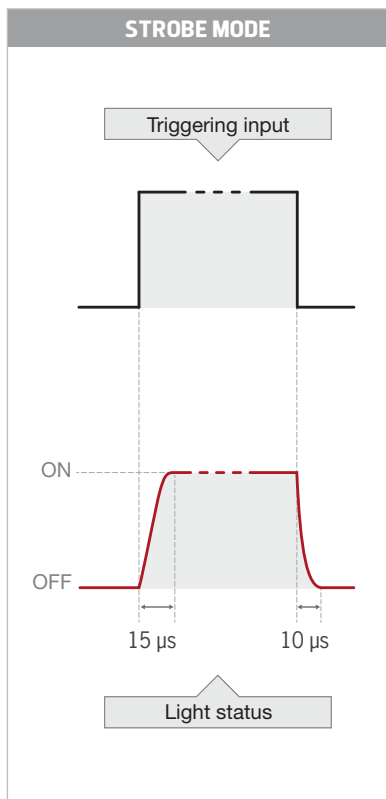

POWER SUPPLY

Minimum functioning voltage	21.6 VDC
Normal functioning voltage	24 VDC \pm10%
Maximum functioning voltage	26.4 VDC
Strobe signal max consumption	5 mA

OPERATING CONDITIONS

-20°C / +60°C (-4°F / +140°F).
 80% of humidity without condensation.
 No thermal shock (max temperature variation:
 10°C / 18°F in 24h).
 Not for outdoor use.



WATERPROOF IP69K WASHDOWN BARLIGHT

TECHNICAL USER GUIDE

P6/8

■ MAXIMUM POWER CONSUMPTION

Illumination Size	LEDs	Fans	Total
125 mm	9.6 W	14.5 W	24.1 W
250 mm	19.2 W	14.5 W	33.7 W
375 mm	28.8 W	14.5 W	43.3 W
500 mm	38.4 W	29 W	67.4 W
625 mm	48 W	29 W	77 W
750 mm	57.6 W	29 W	86.6 W
875 mm	67.2 W	29 W	96.2 W
1000 mm	76.8 W	29 W	105.8 W
1125 mm	86.4 W	29 W	115.4 W
1250 mm	96 W	43.5 W	139.5 W

VOLTAGE DROP

Dimensions	125	250	375	500	625	750	875	1000	1125	1250
Max voltage drop in the bar (V)	0.01	0.03	0.06	0.11	0.17	0.25	0.34	0.44	0.56	0.69
Power supply cable : 5x0,34 ² max length for acceptable voltage drop (m)*	180	90	60	43	34	27	23	20	17	15

* For longer power supply cable, increase the section of the copper wire.

■ CLEANING

List of permitted chemicals, solvents and detergents that can be applied to the product for cleaning purposes without adverse effect. Recommended maximum cleaning pressure of 80 bar at minimum distance of 100mm from the product. Maximum temperature of water in cleaning process is 80 degrees C, but take care to never clean a cold product with warm water. Refer to Operating Guidance section on page 2 for more information. Use of any other cleaning agent could damage the product and invalidate the Warranty.

CHEMICAL PRODUCTS, SOLVENTS, ETC.

A - General

- Arsenic acid
- Butyric acid, up to 5%
- Citric acid, up to 20%
- Hydrochloric acid
- Hydrofluoric acid, up to 20%
- Formic acid, up to 2%
- Lactic acid, up to 20%
- Nitric acid, up to 40%
- Oxalic acid
- Phosphoric acid, up to 50%
- Picric acid, 1% in water
- Acid for accumulators
- Sulfurous acid, up to 5%
- Sulfuric acid, up to 30%
- Stearic acid
- Calculous acid, up to 50%



- Uric acid, up to 20%
- Alum
- Arsenic
- Benzene
- Potassium dichromate
- Sodium bisulfite
- Sodium carbonate
- Potassium carbonate
- Sodium chlorate
- Aluminium chloride
- Calcium chloride
- Stannous tin chloride
- Magnesium chloride
- Potassium chloride
- Sodium chloride
- Sulfuryl chloride
- Ferrous chloride
- Ferric chloride
- Potassium cyanide
- Cyclohexane
- Diethylene glycol
- Oxygenated water, up to 30%
- Soapy water
- Turpentine spirit
- Petroleum ether
- Glycerin
- Glycol
- Heptane
- Hexane
- Calcium hydrochlorite
- Sodium hydrochlorite
- Iodine, metallic
- Lime milk
- Potash
- Lye at 30%
- Mercury
- Monobromonaphthalene
- Silver nitrate
- Potassium nitrate
- Aluminium oxalate
- Perchloroethylene
- Potassium permanganate
- Petroleum
- Propylene

- Soda
- Sulfur
- Aluminium sulphate
- Ammonium sulphate
- Copper sulphate
- Magnesium sulphate
- Manganese sulphate
- Nickel sulphate
- Sodium sulphate
- Solid zinc sulphate
- Watery zinc sulphate
- Sodium sulphide
- Triethylamine
- White Spirit
- Green vitriol

B - Brand

- CLOPHEN® T55, A 60
- PALATINOL® K
- SANGAJOL®
- TERAPIN®

DISINFECTANT PRODUCTS

A - General

- Lime chloride
- Oxygenated water, up to 40%
- Lugol's solution
- Sublimation

B - Brand

- BAKTOLAN®, up to 5%
- CHINOSOL®, up to 1%
- CHLORAMIN®, solution
- ELMOCID® GAMMA, up to 2%
- MEFAROL®, up to 1%
- MERCKOJOD®, up to 1%
- MERFEN®
- PERHYDROL®
- PERODIN®
- SAGROTAN®, up to 2%
- ZEPHIROL®, up to 5%

CLEANING PRODUCT

A - General

- Acids, see **chemical products**
- Alcohol, up to 30%
- Benzene
- Bleach
- Soapy water
- Turpentine spirit
- Petroleum ether
- Detergents, see **chemical products**
- Petroleum
- Soda
- Ammoniacal solution
- White Spirit

B - Brand

- AJAX®
- BFK-nettoyant®
- BÖTTCHERIN®
- BURMAT®
- BURNUS®
- CILLIT-GRÜN®
- DOR®
- DOSYL
- DOSYLAN®
- FAKO® - Polishing paste
- FAKO® - Polishing product
- FEWA®
- FRAPPIN®
- FÜLLBOX
- KUR® - antistatic and cleaning
- LAVAPLEX®
- NULL-NULL®
- PERSIL®
- PLEXIKLAR®
- PRIL®
- REI®
- SEIFIX®
- SPÜLI®
- WC-00®



WATERPROOF IP69K WASHDOWN BARLIGHT TECHNICAL USER GUIDE

P8/8

■ USER SAFETY

Do not modify or dismantle all or part of the product.

Respect the power supply voltages and the connection terminals.

Ensure power supply is switched off whilst connecting product and turn on only once product is fully connected. Failure to do this may damage the product and invalidate the Warranty

Do not stare at the lighting source directly.

Follow advice below for installation to minimise operator exposure to the light source.



INSTALLATION GUIDANCE:

- Forbid or limit the direct access to the lighting source (exposure into the radiation axis).
- Establish a security perimeter to prevent the operators from approaching the lighting source beyond the recommendations of the manufacturer.
- If the workstation permits it, introduce a filter that will stop the lighting radiation under a fixed or adjustable frame between the source and the operator. When these measures cannot be implemented, supply the operators with glasses (class 4) available from TPL Vision.

It is the responsibility of the persons installing this product to ensure that all means possible (such as those stated above) have been implemented to reduce exposure of the machine operators to the light emitted from this product.



Brenchley House, School Road
Charing, Kent TN27 0JW
United Kingdom

TPL VISION
IS AN **ISO 9001**
CERTIFIED MANUFACTURER

+44 (0)1738 310 392

contact@tpl-vision.co.uk

www.tpl-vision.com